

quality prefabricated roof components

pc-1dhp

standard construction - with damper holding plate

Heavy gage galvanized steel, unitized, fully mitered corners, all seams welded, 1-1/2" thick rigid fiberglass insulation pressure treated wood nailer. All curbs are internally reinforced in larger sizes.

Damper holding plate included with roof curb to permit easy installation of a backdraft damper. Galvanized steel construction.



245 eisenhower lane south • lombard, illinois 60148
630.705.1920 • 800.243.3018 • fax 630.705.1930
www.patecurbs.com • e-mail: sales@patecurbs.com

Customer:

PO:

Project:

Address:

Address:

Notes:

pc-1dhp

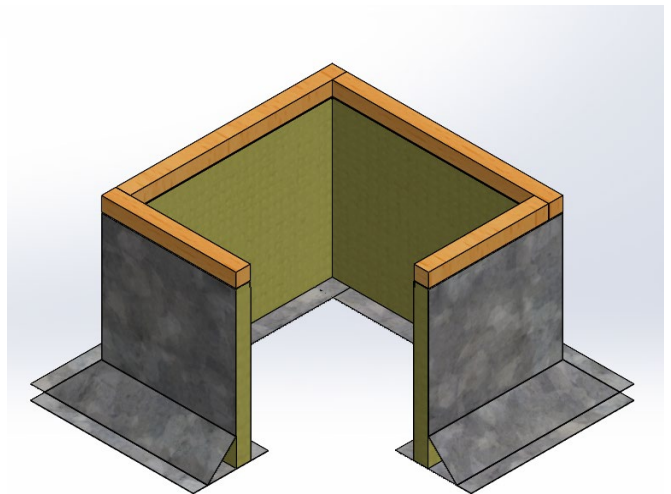
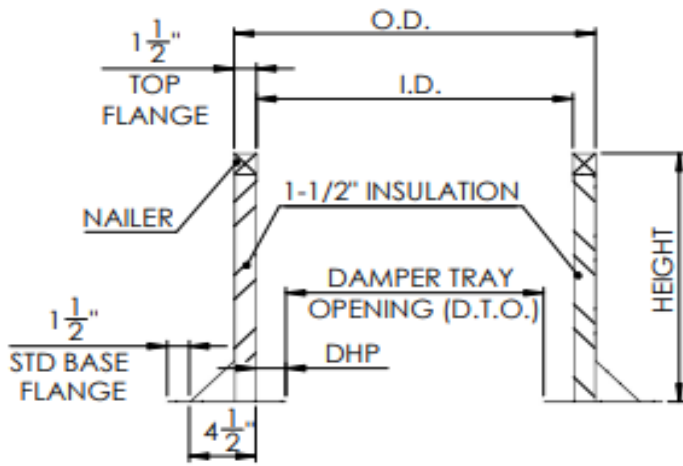

decks with lightweight fill or tapered insulation

roof curb requirements

quantity	style	dimensions - od		dimensions - id		d.h.p.	d.t.o. opening		height	notes/tag
		length	width	length	width		length	width		